



Exclusive Interior Fittings

Since 1999



EXCLUSIVE INTERIOR FITTING

**WELCOME TO THE FUTURE OF
INTELLIGENT FURNITURE
HARDWARE & ACCESSORIES**

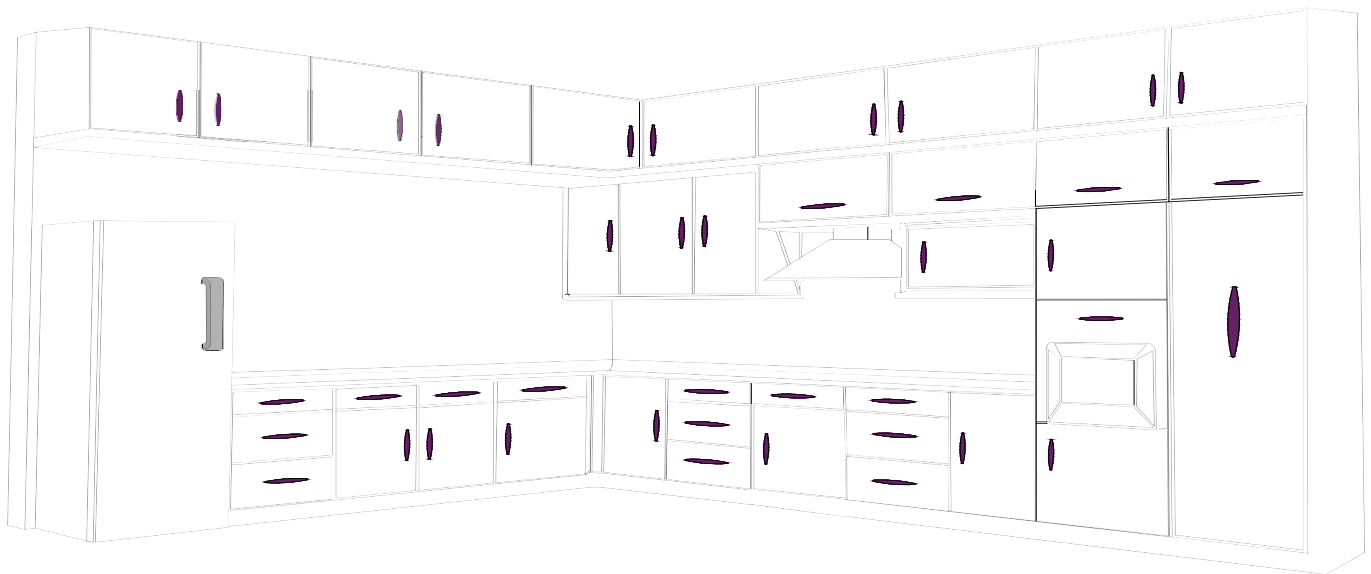
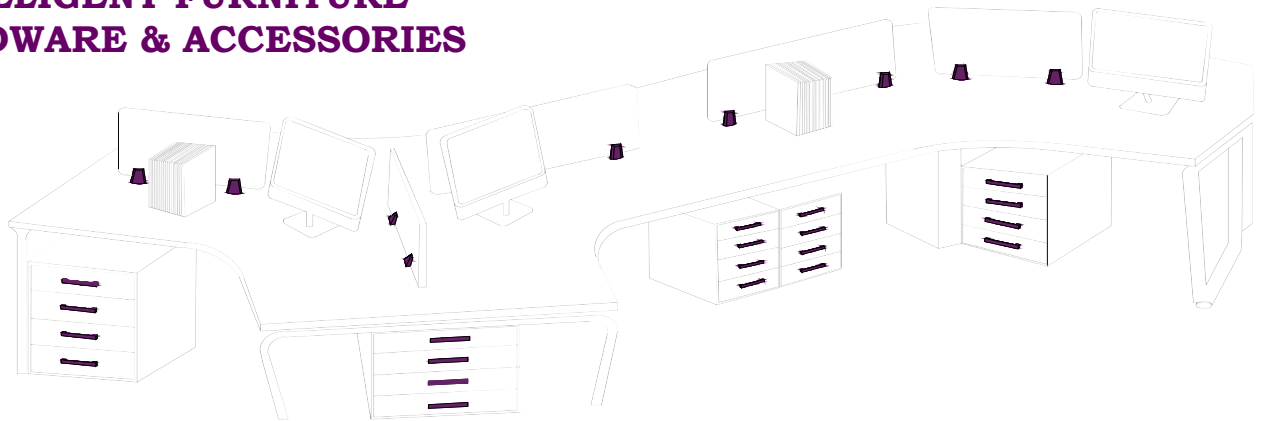

SOFA LEG CATALOGUE

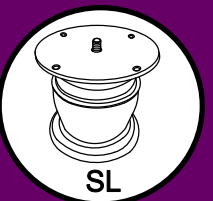

About Us

Our story

KOMAL MANUFACTURING COMPANY HAS BEEN A MAJOR PLAYER IN THE HANDLE INDUSTRY FOR MORE THAN 25 YEARS. THE PIONEER OF THIS BUSINESS WAS MY FATHER MR PRADIP MEHTA UNDER WHOSE GUIDANCE THE COMPANY FLOURISHED AND NOW IT IS KNOWN AS KONARK MANUFACTURING COMPANY. SECOND GENERATION IS RUNNING THIS BUSINESS, THIS MAKES US YOUNG, HIGH ENERGISED AND PROFESSIONAL AND EXTREMELY CUSTOMER ORIENTED.

Management

THE MANAGEMENT TEAM AND THE EMPLOYEES ARE EXPERIENCED IN THEIR AREA. INNOVATING AND INTRODUCING NEW PRODUCTS IS OUR KEY TO BE UNIQUE IN THE MARKET.

WE HAVE AN IN-HOUSE TEAM OF CREATIVE PRODUCT DESIGNERS WHO ARE CONTINUOUSLY WORKING TOWARDS DEVELOPING INNOVATIVE DESIGNS THAT WILL SET NEW TRENDS IN MARKET. THE MANUFACTURING PLANT IS WELL EQUIPED WITH THE LATEST TECHNOLOGY MACHINES AND A TECHNICALLY QUALIFIED TEAM TO MEET THE INCREASING NEEDS OF THE CUSTOMER.

OUR MISSION

WE ARE COMMITTED TO PROVIDE EXCELLENT QUALITY GOODS AND SERVICES TO OUR CUSTOMERS AND TO MEET OUR GOAL, ORGANISATION SHALL STRIVE. EXCELLENT QUALITY OF PRODUCTS, PROMPT AND POSITIVE RESPONSE, ON TIME DELIVERY OF GOODS WITH A MISSION TO MAKE CONTINUAL IMPROVEMENT IN ALL ASPECTS.

OUR AIM

WE IN KONARK BELIEVE TO CREATE AND CULTIVATE LONG TERM RELATIONSHIPS WITH OUR CLIENTS. CUSTOMERS HAVE THE POWER TO CHOOSE IN THIS COMPETITIVE AND OPEN MARKET.

OUR AIM IS TO PROVIDE HIGH QUALITY SERVICE, ALONG WITH FAIR AND COMPETITIVE PRICING AND THUS OFFERING THE CUSTOMER OPTIMAL RETURN ON INVESTMENT.

FOUNDER AND CEO

AS THE FOUNDER OF KONARK MANUFACTURING COMPANY, MR CHETAN IS RESPONSIBLE FOR RUNNING ALL FACETS OF THE BUSINESS. HE IS A VISIONARY THINKER WITH GLOBAL PERSPECTIVE AND ENTREPRENEURIAL DRIVE. HE HAS AN EXPERIENCE OF OVER 20 YEARS IN THIS FIELD.

AS A MECHANICAL ENGINEER HIMSELF HE IS IN DEPTH INVOLVED WITH ALL THE ASPECTS OF MANUFACTURING. DEVELOPING A COMPREHENSIVE MARKETING PLAN AND IMPLEMENTING IT TO INCREASE BRAND AWARENESS AND RECOGNITION. ESTABLISHED A NETWORK OF LOCAL SUPPLIERS FOR EFFICIENT SOURCING OF MATERIALS.



ATTRACTIVE
FINISH



WEATHER PROTECTED
PLATING



VIRGIN MATERIAL



SENSIBLE DESIGN



VARIOUS PATTERN



EASY TO CLEAN



CORROSION
RESISTANCE



FOCUS ON
INNOVATION



SCRATCH
RESISTANCE



FINGERPRINT
RESISTANCE



OLEOPHOBIC
COATING

Model : SL-001

Size	Product Code	H	C
75mm	SL-001 75	75	60
100mm	SL-001 100	100	60
125mm	SL-001 125	125	60
150mm	SL-001 150	150	60

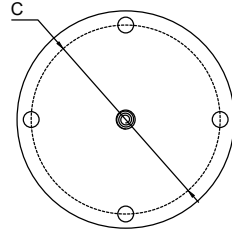
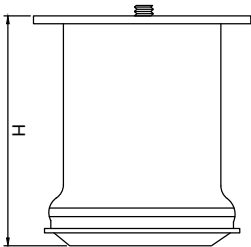

Model : SL-002

Size	Product Code	H	C
75mm	SL-002 75	75	60
100mm	SL-002 100	100	60
125mm	SL-002 125	125	60
150mm	SL-002 150	150	60

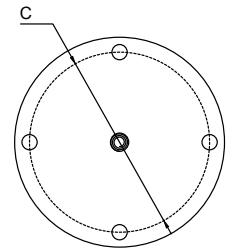
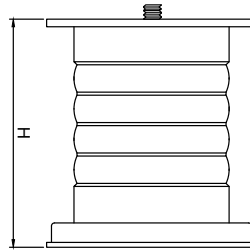

Model : SL-003

Size	Product Code	H	C
75mm	SL-003 75	75	60
100mm	SL-003 100	100	60
125mm	SL-003 125	125	60
150mm	SL-003 150	150	60

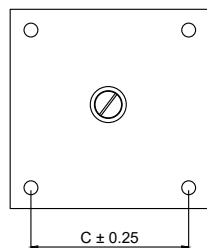
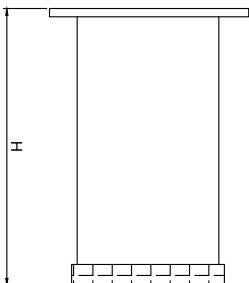

Model : SL-004

Size	Product Code	H	C
75mm	SL-004 75	75	73
100mm	SL-004 100	100	73
125mm	SL-004 125	125	73
150mm	SL-004 150	150	73

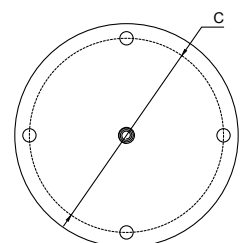
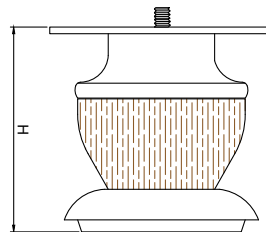

FINISH:

MT	CP	SP	MC	BM	RG	BA	CA
Matt	Chrome	Satin	Matt Chrome	Black Matt	Rose Gold	Brass Antique	Copper Antique

★ Best Sellers.

Model : SL-005

Size	Product Code	H	C
★ 75mm	SL-005 75	75	48
★ 100mm	SL-005 100	100	48
125mm	SL-005 125	125	48
150mm	SL-005 150	150	48

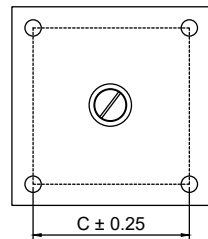
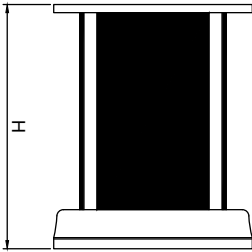

Model : SL-006

Size	Product Code	H	C
★ 75mm	SL-006 75	75	60
★ 100mm	SL-006 100	100	60
125mm	SL-006 125	125	60
150mm	SL-006 150	150	60

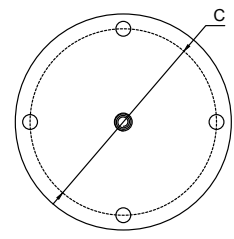
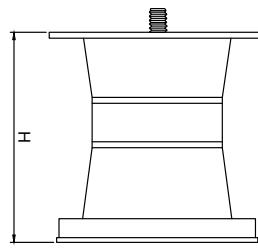

Model : SL-007

Size	Product Code	H	C
★ 75mm	SL-007 75	75	60
★ 100mm	SL-007 100	100	60
125mm	SL-007 125	125	60
★ 150mm	SL-007 150	150	60

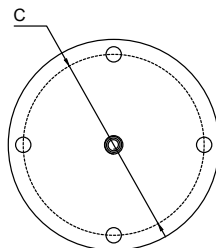
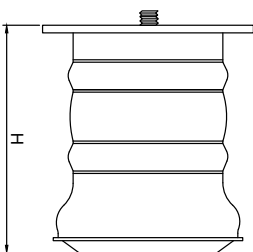

Model : SL-008

Size	Product Code	H	C
★ 75mm	SL-008 75	75	60
★ 100mm	SL-008 100	100	60
★ 125mm	SL-008 125	125	60
★ 150mm	SL-008 150	150	60

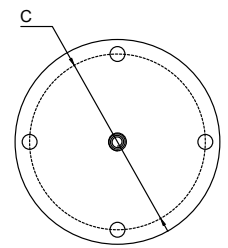
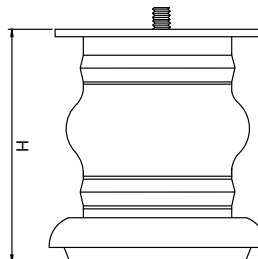

FINISH:

MT	CP	SP	MC	BM	RG	BA	CA
Matt	Chrome	Satin	Matt Chrome	Black Matt	Rose Gold	Brass Antique	Copper Antique

★ Best Sellers.]

Model : SL-009

Size	Product Code	H	C
★ 75mm	SL-009 75	75	54
★ 100mm	SL-009 100	100	54
★ 125mm	SL-009 125	125	54
★ 150mm	SL-009 150	150	54

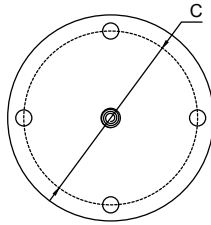
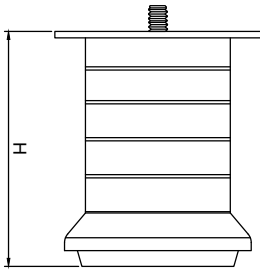
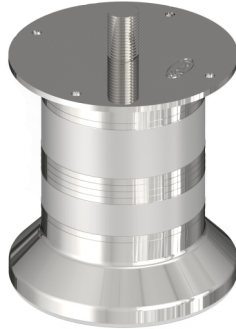

Model : SL-010

Size	Product Code	H	C
★ 75mm	SL-010 75	75	60
★ 100mm	SL-010 100	100	60
★ 125mm	SL-010 125	125	60
★ 150mm	SL-010 150	150	60

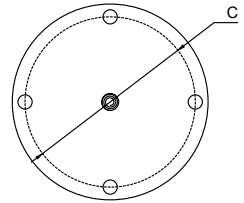
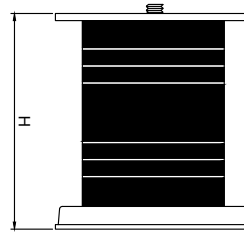

Model : SL-011

Size	Product Code	H	C
★ 75mm	SL-011 75	75	60
★ 100mm	SL-011 100	100	60
125mm	SL-011 125	125	60
150mm	SL-011 150	150	60

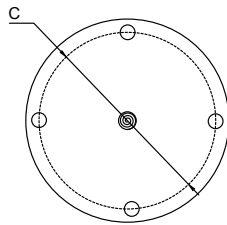
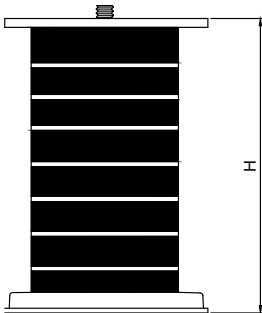

Model : SL-012

Size	Product Code	H	C
★ 75mm	SL-012 75	75	72
★ 100mm	SL-012 100	100	72
125mm	SL-012 125	125	72
150mm	SL-012 150	150	72

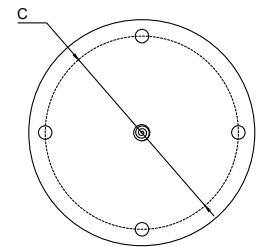
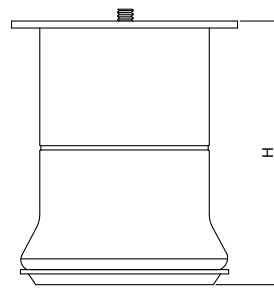

FINISH:

MT	CP	SP	MC	BM	RG	BA	CA
Matt	Chrome	Satin	Matt Chrome	Black Matt	Rose Gold	Brass Antique	Copper Antique

★ Best Sellers.]

Model : SL-013

Size	Product Code	H	C
★ 75mm	SL-013 75	75	73
★ 100mm	SL-013 100	100	73
★ 125mm	SL-013 125	125	73
★ 150mm	SL-013 150	150	73

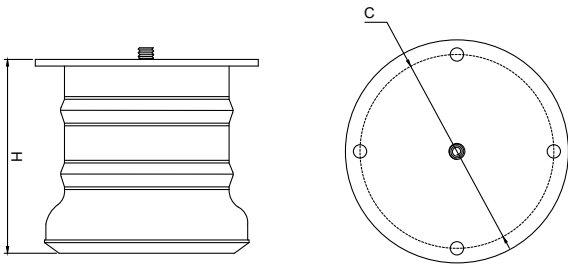

Model : SL-014

Size	Product Code	H	C
★ 75mm	SL-014 75	75	73
★ 100mm	SL-014 100	100	73
★ 125mm	SL-014 125	125	73
★ 150mm	SL-014 150	150	73

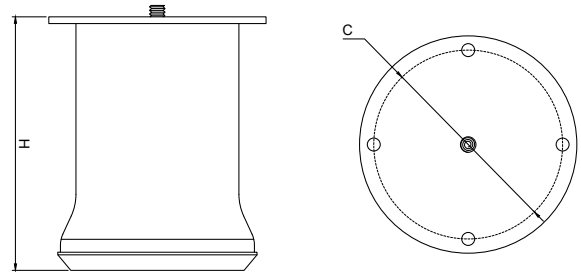

Model : SL-015

Size	Product Code	H	C
★ 75mm	SL-015 75	75	55
★ 100mm	SL-015 100	100	55
★ 125mm	SL-015 125	125	55
★ 150mm	SL-015 150	150	55

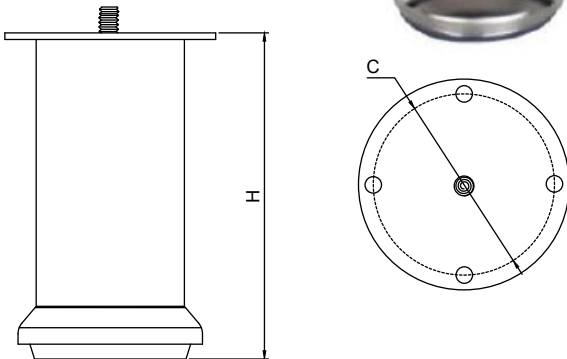

Model : SL-016

Size	Product Code	H	C
★ 75mm	SL-016 75	75	60
★ 100mm	SL-016 100	100	60
★ 125mm	SL-016 125	125	60
★ 150mm	SL-016 150	150	60

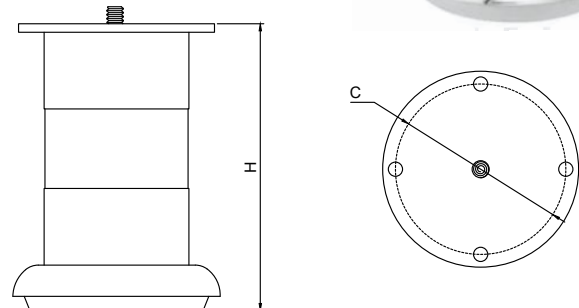

FINISH:

MT	CP	SP	MC	BM	RG	BA	CA
Matt	Chrome	Satin	Matt Chrome	Black Matt	Rose Gold	Brass Antique	Copper Antique

★ Best Sellers.]

Model : SL-017

Size	Product Code	H	C
★ 75mm	SL-017 75	75	43
★ 100mm	SL-017 100	100	43
★ 125mm	SL-017 125	125	43
★ 150mm	SL-017 150	150	43

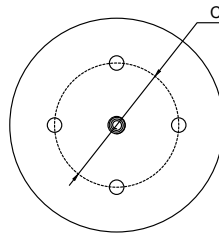
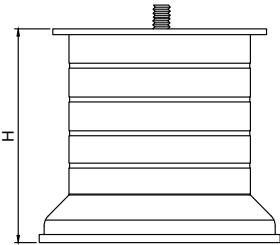
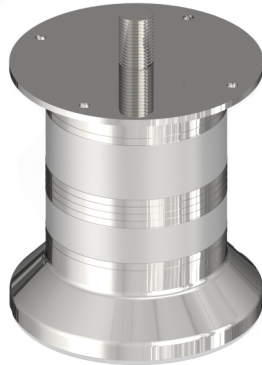

Model : SL-018

Size	Product Code	H	C
★ 75mm	SL-018 75	75	50
★ 100mm	SL-018 100	100	50
125mm	SL-018 125	125	50
150mm	SL-018 150	150	50

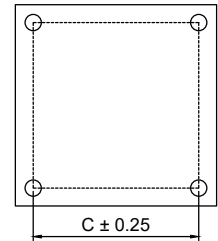
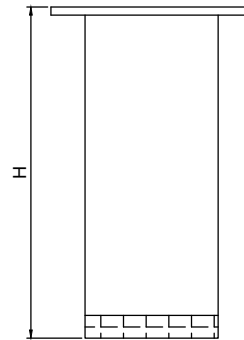

Model : SL-019

Size	Product Code	H	C
★ 75mm	SL-019 75	75	73
★ 100mm	SL-019 100	100	73
★ 125mm	SL-019 125	125	73
★ 150mm	SL-019 150	150	73

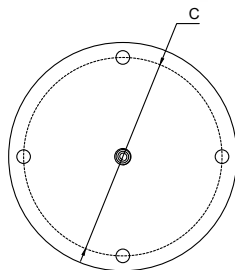
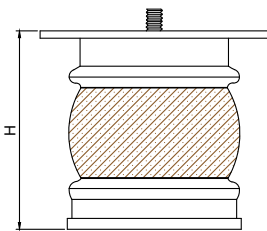

Model : SL-020

Size	Product Code	H	C
★ 75mm	SL-020 75	75	50
★ 100mm	SL-020 100	100	50
125mm	SL-020 125	125	50
★ 150mm	SL-020 150	150	50

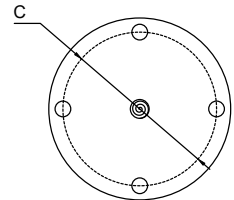
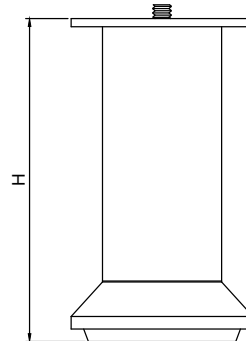

FINISH:

MT	CP	SP	MC	BM	RG	BA	CA
Matt	Chrome	Satin	Matt Chrome	Black Matt	Rose Gold	Brass Antique	Copper Antique

★ Best Sellers.

Model : SL-021

Size	Product Code	H	C
75mm	SL-021 75	75	60
100mm	SL-021 100	100	60
125mm	SL-021 125	125	60
150mm	SL-021 150	150	60

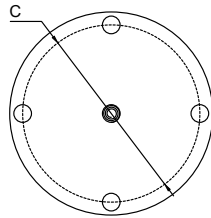
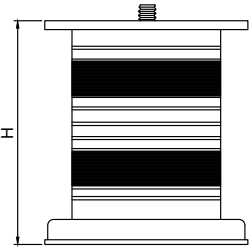

Model : SL-022

Size	Product Code	H	C
75mm	SL-022 75	75	60
100mm	SL-022 100	100	60
125mm	SL-022 125	125	60
150mm	SL-022 150	150	60

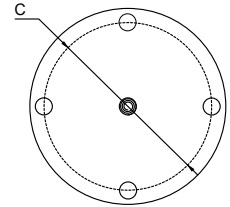
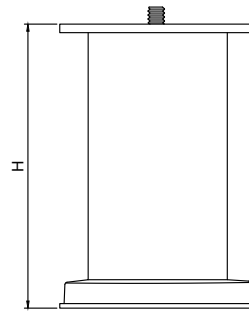

Model : SL-023

Size	Product Code	H	C
75mm	SL-023 75	75	60
100mm	SL-023 100	100	60
125mm	SL-023 125	125	60
150mm	SL-023 150	150	60

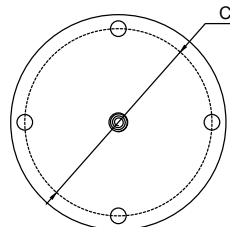
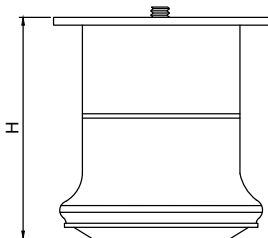

Model : SL-024

Size	Product Code	H	C
75mm	SL-024 75	75	87
100mm	SL-024 100	100	87
125mm	SL-024 125	125	87
150mm	SL-024 150	150	87

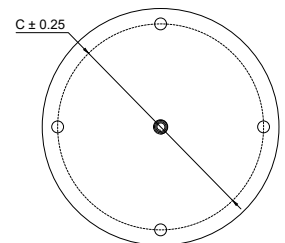
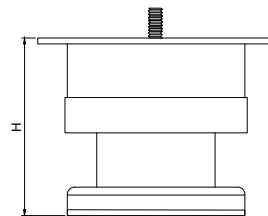

FINISH:

MT	CP	SP	MC	BM	RG	BA	CA
Matt	Chrome	Satin	Matt Chrome	Black Matt	Rose Gold	Brass Antique	Copper Antique

★ Best Sellers.

Model : SL-025

Size	Product Code	H	C
75mm	SL-025 75	75	60
★ 100mm	SL-025 100	100	60
★ 125mm	SL-025 125	125	60
150mm	SL-025 150	150	60

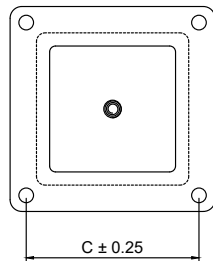
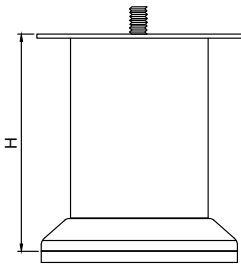

Model : SL-026

Size	Product Code	H	C
★ 75mm	SL-026 75	75	40
★ 100mm	SL-026 100	100	40
125mm	SL-026 125	125	40
150mm	SL-026 150	150	40

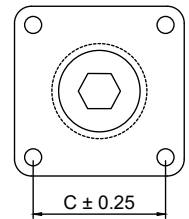
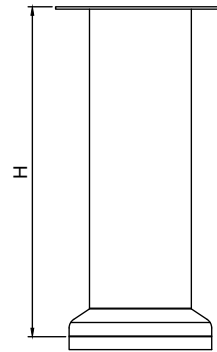

Model : SL-027

Size	Product Code	H	C
★ 75mm	SL-027 75	75	48
★ 100mm	SL-027 100	100	48
125mm	SL-027 125	125	48
★ 150mm	SL-027 150	150	48

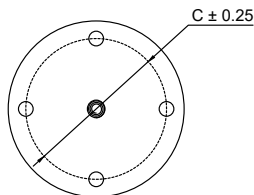
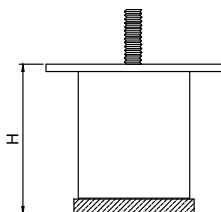

Model : SL-028

Size	Product Code	H	C
★ 75mm	SL-028 75	75	60
★ 100mm	SL-028 100	100	60
★ 125mm	SL-028 125	125	60
★ 150mm	SL-028 150	150	60

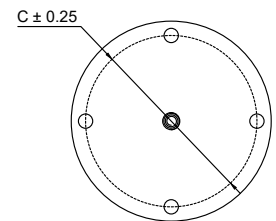
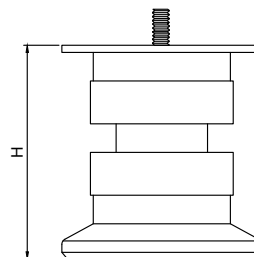
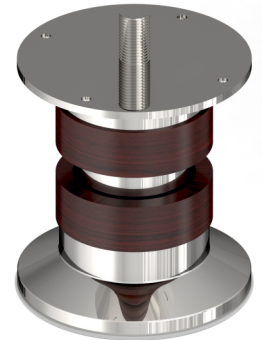

FINISH:

MT	CP	SP	MC	BM	RG	BA	CA
Matt	Chrome	Satin	Matt Chrome	Black Matt	Rose Gold	Brass Antique	Copper Antique

★ Best Sellers.]

Model : SL-029

Size	Product Code	H	C
75mm	SL-029 75	75	60
100mm	SL-029 100	100	60
125mm	SL-029 125	125	60
150mm	SL-029 150	150	60

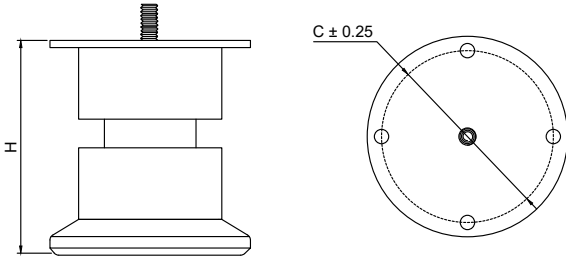

Model : SL-030

Size	Product Code	H	C
75mm	SL-030 75	75	60
100mm	SL-030 100	100	60
125mm	SL-030 125	125	60
150mm	SL-030 150	150	60

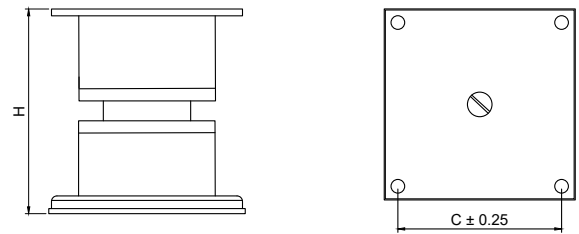
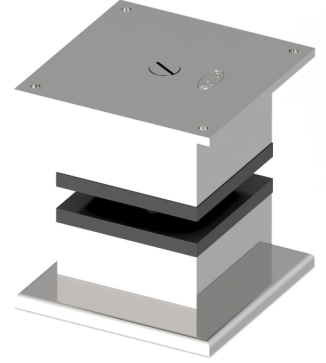

Model : SL-031

Size	Product Code	H	C
75mm	SL-031 75	75	60
100mm	SL-031 100	100	60
125mm	SL-031 125	125	60
150mm	SL-031 150	150	60

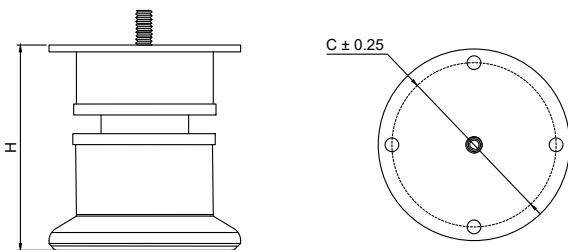

Model : SL-032

Size	Product Code	H	C
75mm	SL-032 75	75	60
100mm	SL-032 100	100	60
125mm	SL-032 125	125	60
150mm	SL-032 150	150	60

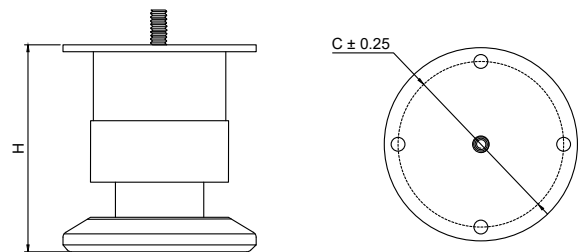

FINISH:

MT	CP	SP	MC	BM	RG	BA	CA
Matt	Chrome	Satin	Matt Chrome	Black Matt	Rose Gold	Brass Antique	Copper Antique

★ Best Sellers.

Model : SL-033

Size	Product Code	H	C
75mm	SL-033 75	75	75
100mm	SL-033 100	100	75
125mm	SL-033 125	125	75
150mm	SL-033 150	150	75

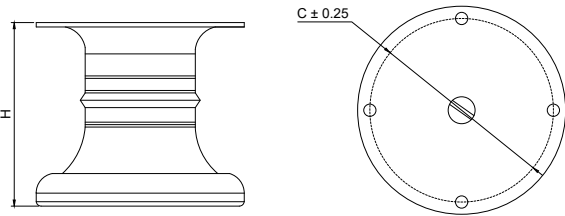

Model : SL-034

Size	Product Code	H	C
75mm	SL-034 75	75	75
100mm	SL-034 100	100	75
125mm	SL-034 125	125	75
150mm	SL-034 150	150	75

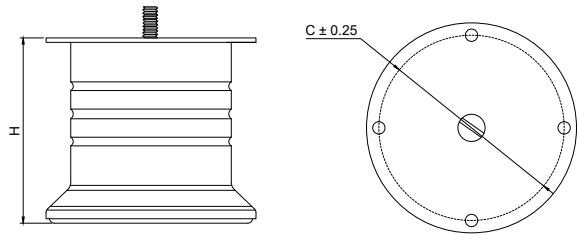

Model : SL-035

Size	Product Code	H	C
75mm	SL-035 75	75	75
100mm	SL-035 100	100	75
125mm	SL-035 125	125	75
150mm	SL-035 150	150	75

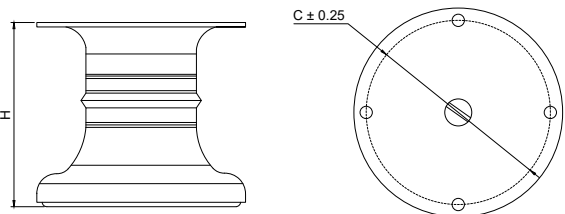

Model : SL-036

Size	Product Code	H	C
50mm	SL-036 50	50	60
75mm	SL-036 75	75	60
100mm	SL-036 100	100	60
150mm	SL-036 150	150	60

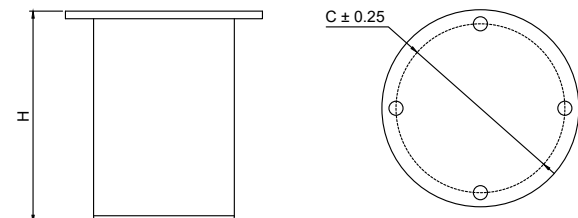

FINISH:

MT	CP	SP	MC	BM	RG	BA	CA
Matt	Chrome	Satin	Matt Chrome	Black Matt	Rose Gold	Brass Antique	Copper Antique

★ Best Sellers.]

Model : SL-037

Size	Product Code	H	C
★ 50mm	SL-037 50	50	60
★ 75mm	SL-037 75	75	60
★ 100mm	SL-037 100	100	60
★ 150mm	SL-037 150	150	60

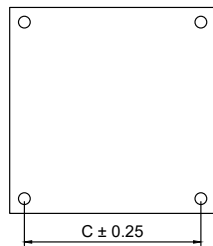
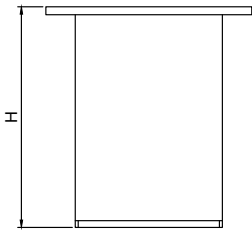

Model : SL-038

Size	Product Code	H	C
★ 75mm	SL-038 75	75	75
★ 100mm	SL-038 100	100	75
★ 125mm	SL-038 125	125	75
★ 150mm	SL-038 150	150	75

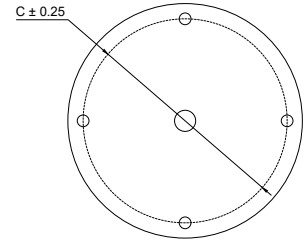
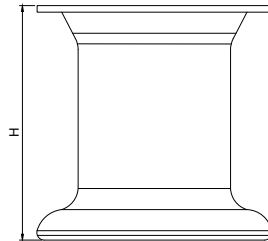

Model : SL-039

Size	Product Code	H	C
★ 50mm	SL-039 50	50	60
★ 75mm	SL-039 75	75	60
★ 100mm	SL-039 100	100	60
★ 150mm	SL-039 150	150	60

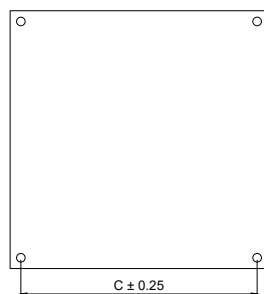
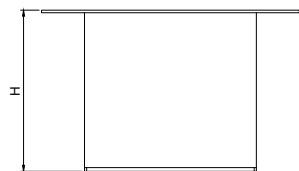

Model : SL-040

Size	Product Code	H	C
★ 75mm	SL-040 75	75	75
★ 100mm	SL-040 100	100	75
★ 125mm	SL-040 125	125	75
★ 150mm	SL-040 150	150	75

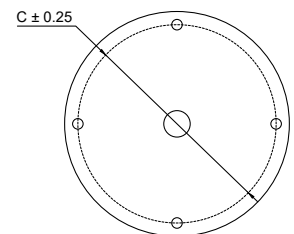
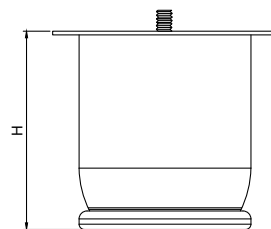

FINISH:

MT	CP	SP	MC	BM	RG	BA	CA
Matt	Chrome	Satin	Matt Chrome	Black Matt	Rose Gold	Brass Antique	Copper Antique

★ Best Sellers.]

Model : SL-041

Size	Product Code	C
★ 120mm	SL-041 120	120

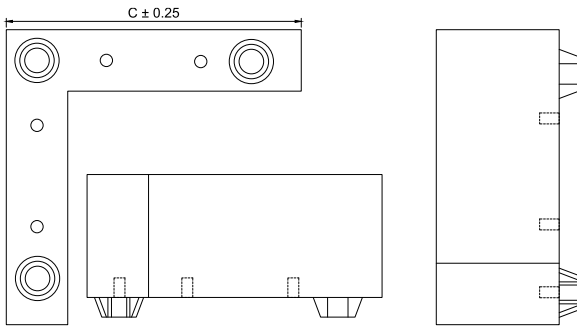
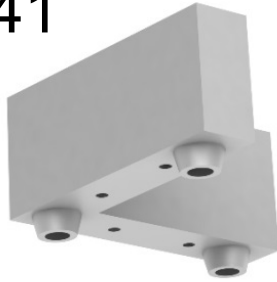

Model : SL-042

Size	Product Code	C
★ 150mm	SL-042 150	150

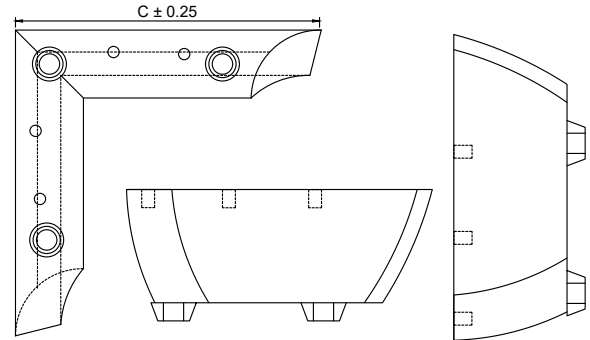

Model : SL-043

Size	Product Code	H	C
★ 75mm	SL-043 43	75	60
★ 100mm	SL-043 100	100	60
125mm	SL-043 125	125	60
★ 150mm	SL-043 150	150	60

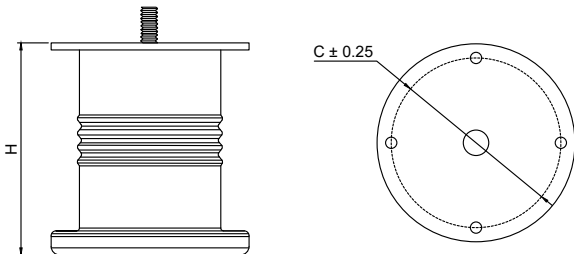

Model : SL-044

Size	Product Code	H	C
★ 75mm	SL-044 75	75	60
★ 100mm	SL-044 100	100	60
125mm	SL-044 125	125	60
150mm	SL-044 150	150	60

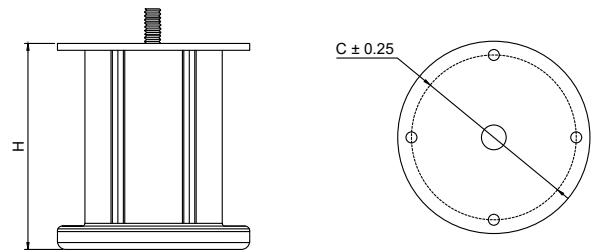

FINISH:

MT	CP	SP	MC	BM	RG	BA	CA
Matt	Chrome	Satin	Matt Chrome	Black Matt	Rose Gold	Brass Antique	Copper Antique

★ Best Sellers.]

Terms & Conditions

1- DISCLAIMER

Manufacturing Agency reserves the right to discontinue or add any product, finish or design without prior notice. The sketches/drawings and images appearing in this price list have been included solely for guidance purposes only. They are not true to scale and do not represent any precise or binding design of the product. Copying or Duplicating the products is strictly prohibited. Only authorized resellers, franchise & distributors appointed by the company are allowed to possess, trade or sell products offered by and from the company. Illegal possession of the goods will result in prosecution.

2- AVAILABILITY

Manufacturing Agency endeavours to keep sufficient stock of the products mentioned in this price list. But orders falling out of average, if not in stock, would be intimated and supplied in due course as specified or agreed by customers in written. Manufacturing Agency requests customers to reconfirm stock position before commitment to the customers.

3- PRICES

All previous prices are superseded by this List Price along with price agreements of any kind with any party. All prices are subject to change without notice. All prices mentioned are Maximum Retail Prices (M.R.P.) i.e. inclusive of all taxes for the end user. All prices are Ex-works and in Indian Rupees (INR) only. The validity period of the price list also applies in case of products that are not included in this price list. All the information provided is subject to error and printing mistakes for which no liability will be accepted.

4- TAX & FREIGHT

Packing, Forwarding & Bardan Charges have to be borne by the buyer. CGST+SGST for Gujarat and IGST for other states would be applicable after the standard discount on the MRP. Additional Freight charges for prompt deliveries by air i.e. courier or flight charges has to be borne by the buyer along with necessary forms. The Tax rate will be subject to change as per the government notifications.

5- ORDERS

Receipt or Possession of this Price List does not grant approval to quote or purchase Manufacturing Agency Products. All orders will be fulfilled by the acceptance of Manufacturing Agency quantity at Manufacturing Agency Price at the time of order. Manufacturing Agency will accept orders via phone, email, fax, sms or courier. Manufacturing Agency reserves the right to decline orders in which the price or quantity of goods is not satisfactory. Any modification to the standard product configuration is considered to be a special order. For a special order the price will vary and no credits will be issued for returned special orders unless authorized by the Directors of Manufacturing Agency. Delivery period of such orders will be decided depending upon the manufacturing process time. Accuracy of phone orders will be determined by the receipt of a written sale order form and an acceptance of the same. The order reference issued on the form will be used for tracking the goods.

6- INVOICE

The final dispatch invoice will be sent to you for confirmation just before the dispatch and a written confirmation for the same will be required by you of that invoice. Any changes in the quantity, price or product etc. has to be rectified immediately and the goods will leave the warehouse only after your confirmation. Any changes will not be accepted later.

7- DELIVERY

We endeavor to make prompt shipment of all orders, but we shall not be held responsible for any loss or damage resulting from delay in filling orders due to causes beyond our control, including delivery of material to us. All responsibility ceases off the goods after it has left our warehouse. Goods intransit are at the risk of the buyer.

Terms & Conditions

8- CLAIMS

All claims due to errors or defects must be submitted, in writing, within 15 days after receipt of goods.

9- PROPER INSTALLATION& MAINTENANCE

Improper installations or any unguided product hampering is not a responsibility of Company.

It is the responsibility of the buyer to ensure the fitness of hardware for the intended purpose. We recommend assessment by appropriate testing in the application and by technical enquiry to our representatives or by understanding the manual provided with the product. Products may be sharp edged or blunt and heavy. Please handle with proper handling techniques and please keep all products away from the reach of children during or before installation. Keep the products in good condition and avoid contact with chemicals, water, paste, dirt and abuse to increase the life of the product. Finishes treated with protective coatings quickly deteriorate if the surface is broken. To prolong the life and maintain the original beauty of the material and the finish, it is important to avoid the use of paint removing solvents, acids, ambro tapes or other strong caustic cleaning solutions. Before painting doors, frames & woodwork. All hardware items should be removed and reinstalled after the paint is dry.

10- RETURNED GOODS

Company will not accept any return goods under any circumstances except manufacturing defects or warehouse mistakes. Customer has up to 6 Months from the date of invoice to return the goods in this case and all goods must be returned in original packaging and be in resalable condition, i.e. unaltered and non-degraded condition along with prior approval. Transportation charges of returned goods must be prepaid by the customer. Product not returned in saleable condition or after 6 Month of issue date is subject to disposal by Company with no credit issued.





Exclusive Interior Fittings.

MADE IN INDIA

MADE FOR WORLD

Mfg. By :

Komal
Manufacturing Co.

Factory Add: Plot No.27 Survey No.224,
Somnath Ind.5, Village:Kothariya,
Gondal Road, Rajkot, 360022.

Mkt.& Dist. By :

Konark
Manufacturing Co.

Office Add: 11/D-502,Neelam Nagar,Phase-2,
Gavan Pada,Mulund (E) Mumbai-400081



www.konark8.com



info@konark8.com



+916357707700

E-mail : chetan@konark8.com

Contact Person : [Chetan Mehta](#)

Contact : [+91-7878757399](tel:+91-7878757399)



MADE IN INDIA
MADE FOR WORLD

