

Model : SL-011

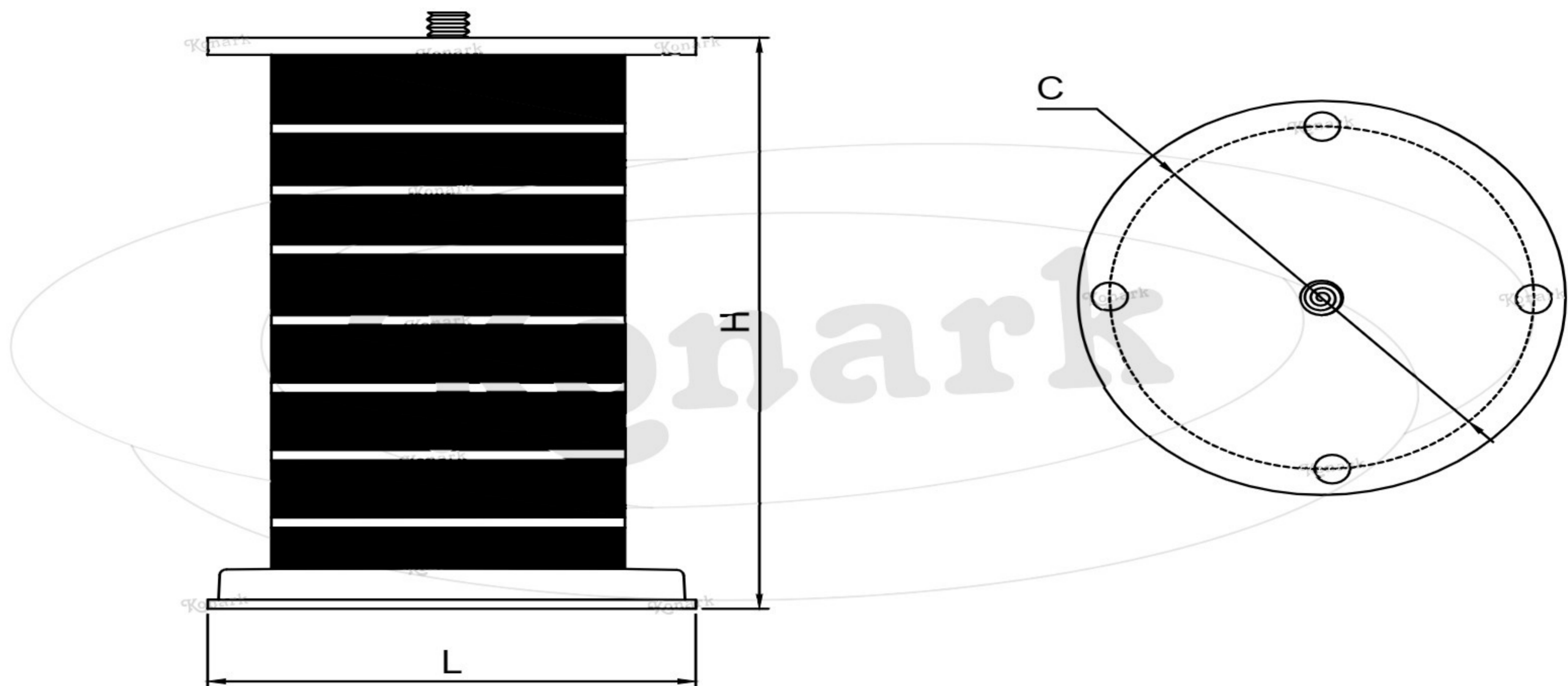

Finish	Size	Product Code	H	C
MT	75mm	SL-011 75	75	60
CP	100mm	SL-011 100	100	60
SP				
MC	125mm	SL-011 125	125	60
BM				
RG	150mm	SL-011 150	150	60
BA				
CA				

