

## Model : SL-025

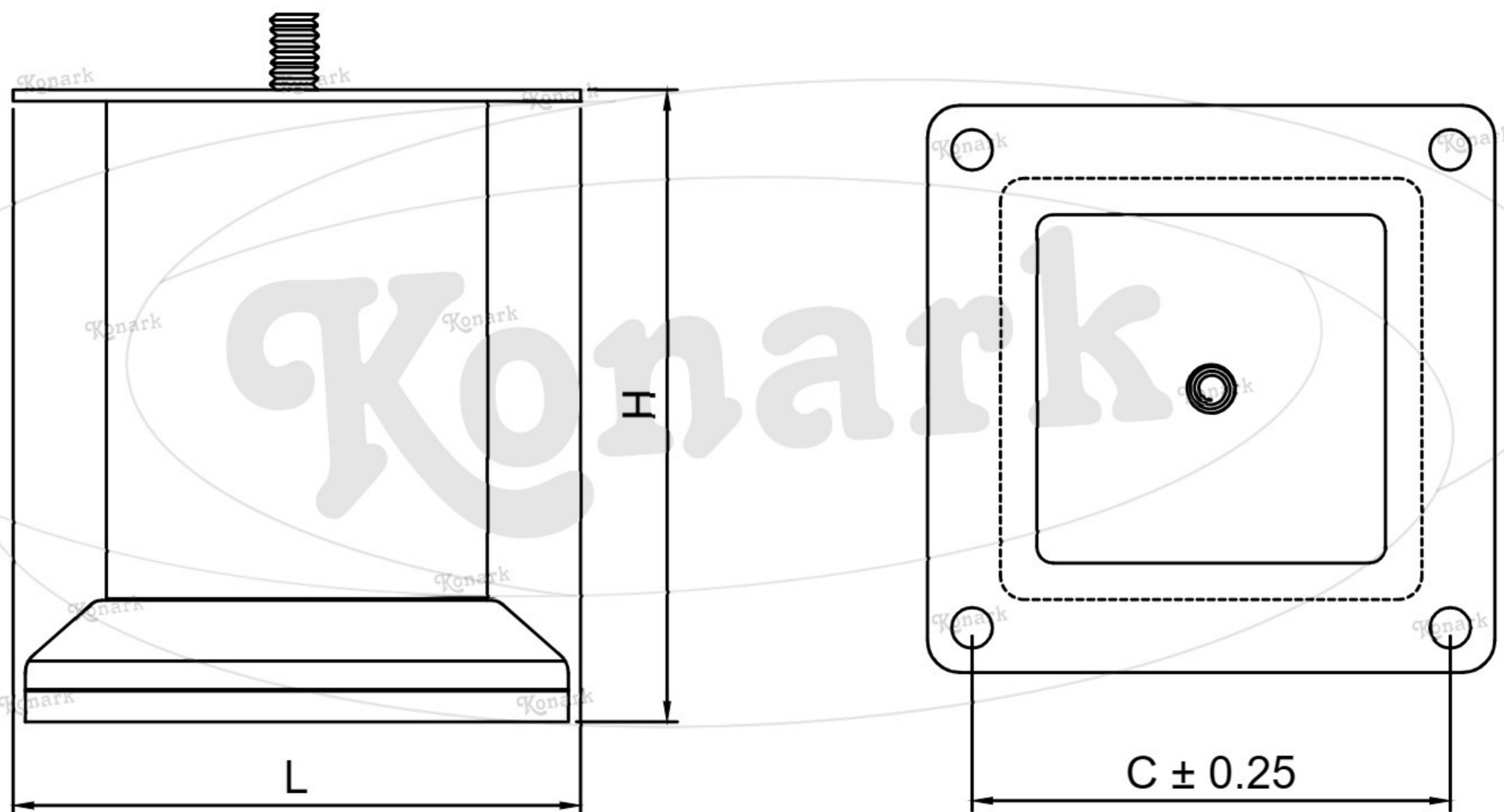

Finish	Size	Product Code	H	C
MT	75mm	SL-025 75	75	60
CP	100mm	SL-025 100	100	60
SP				
MC	125mm	SL-025 125	125	60
BM	150mm	SL-025 150	150	60
RG				
BA				
CA				

