

Model : SL-038

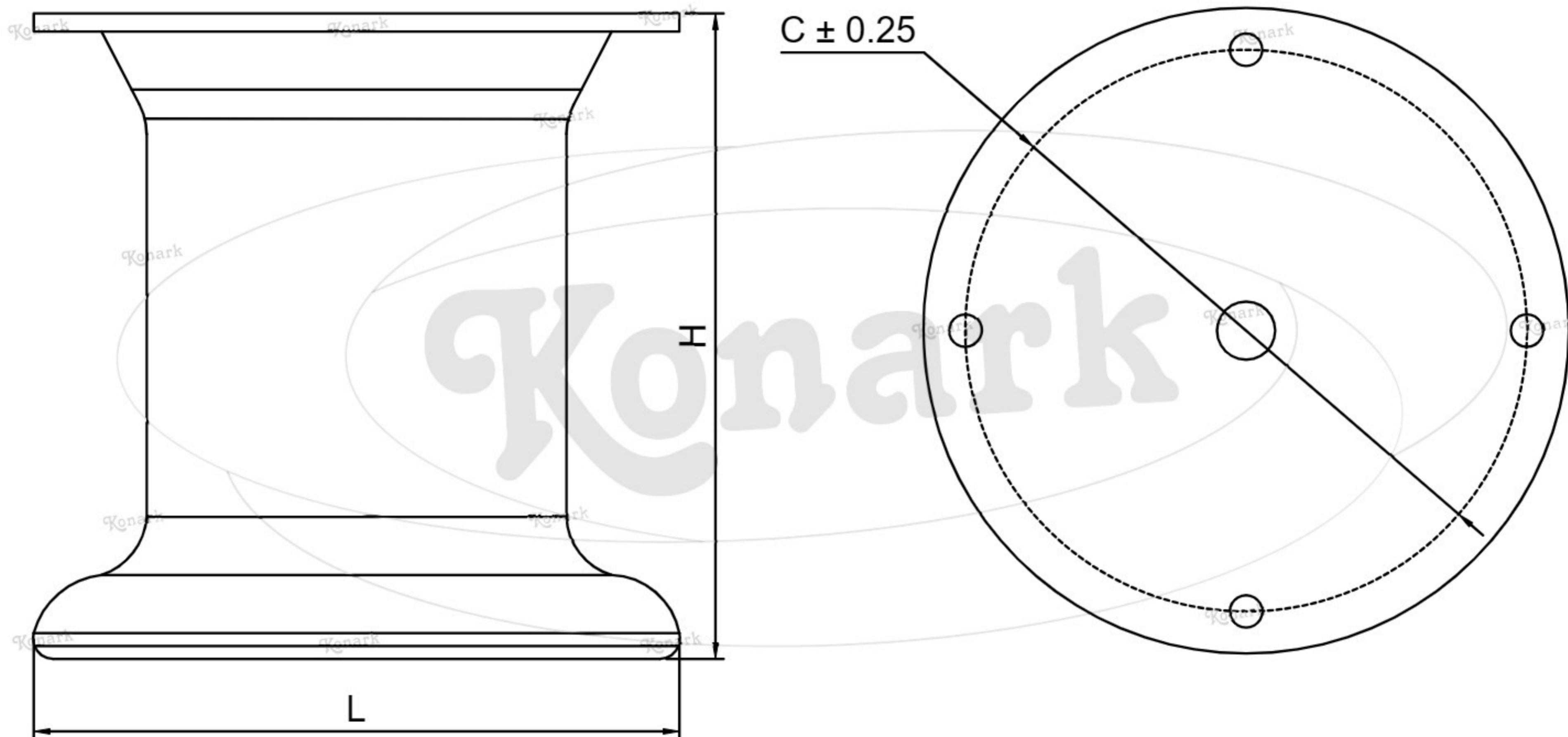

Finish	Size	Product Code	H	C
MT	75mm	SL-038 75	75	75
CP	100mm	SL-038 100	100	75
SP				
MC	125mm	SL-038 125	125	75
BM	150mm	SL-038 150	150	75
RG				
BA				
CA				

