

Model : SL-040

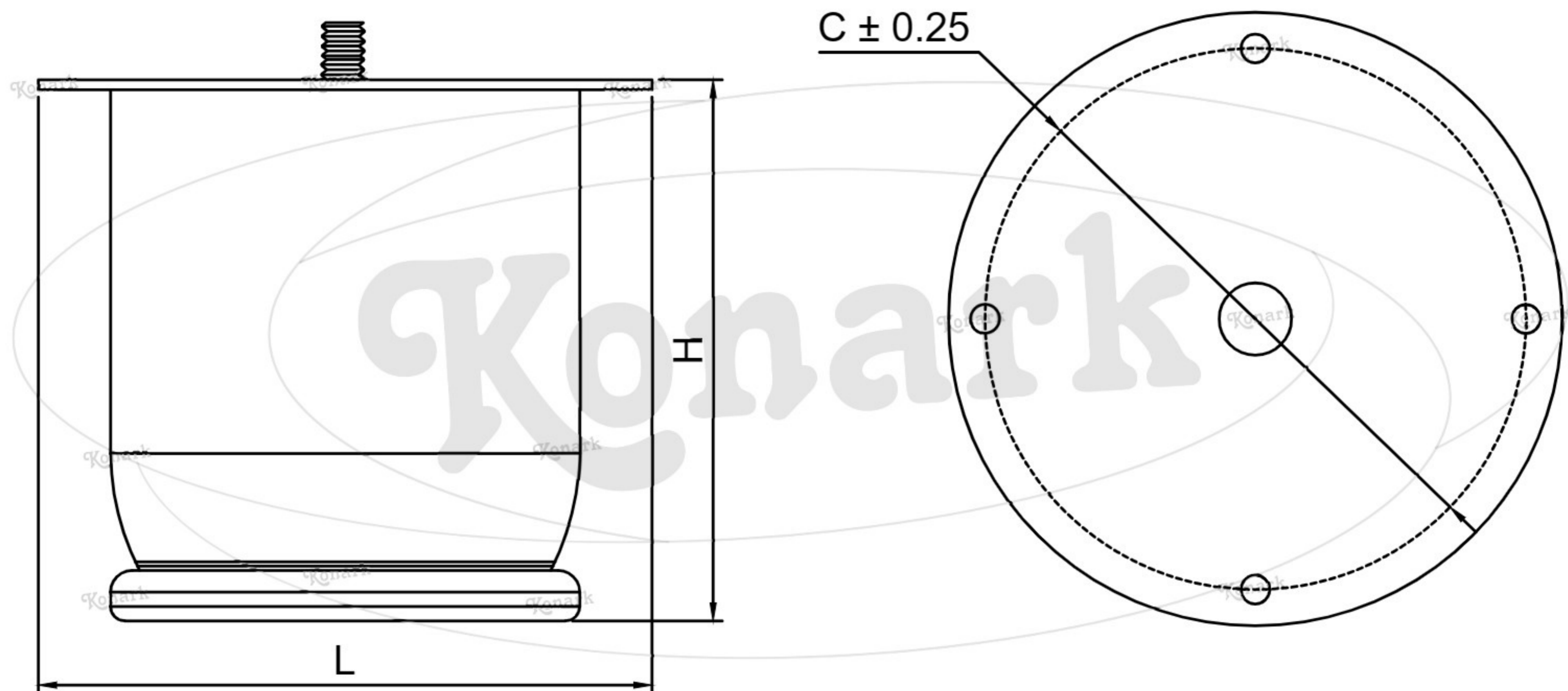

Finish	Size	Product Code	H	C
MT	75mm	SL-040 75	75	75
CP	100mm	SL-040 100	100	75
SP				
MC	125mm	SL-040 125	125	75
BM	150mm	SL-040 150	150	75
RG				
BA				
CA				

