

Model : SL-006

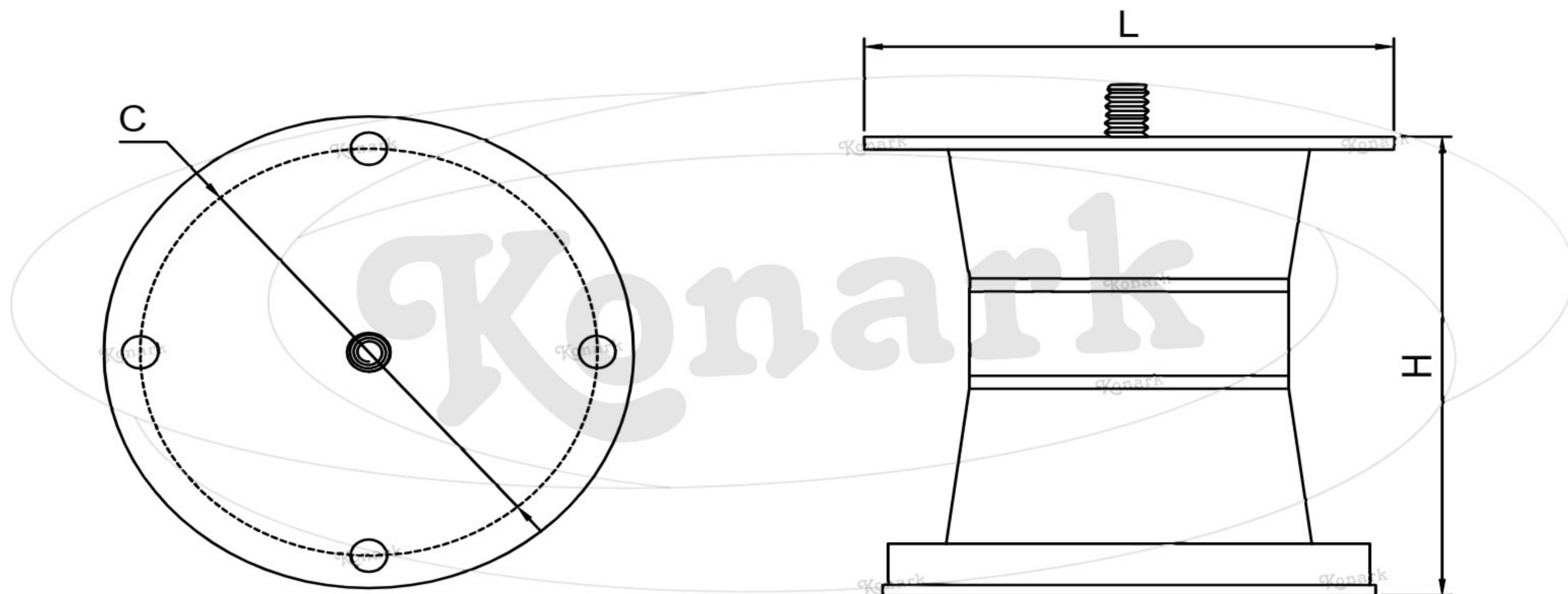

Finish	Size	Product Code	H	C
MT	75mm	SL-006 75	75	63
CP	100mm	SL-006 100	100	63
SP				
MC	125mm	SL-006 125	125	63
BM				
RG	150mm	SL-006 150	150	63
BA				
CA				

